

AI ASIC: Design and Practice (ADaP)

Fall 2023

HDL Simulators & Logic Synthesis

燕博南

Outline



- Verilog HDL Simulators
- Logic Synthesis - A instrumentalism Perspective
 - How to synthesis RTL code to logic gates?

RTL: Register Transfer Level

Part 1

Open-source simulators for HDL

Verilog Simulator Workflow

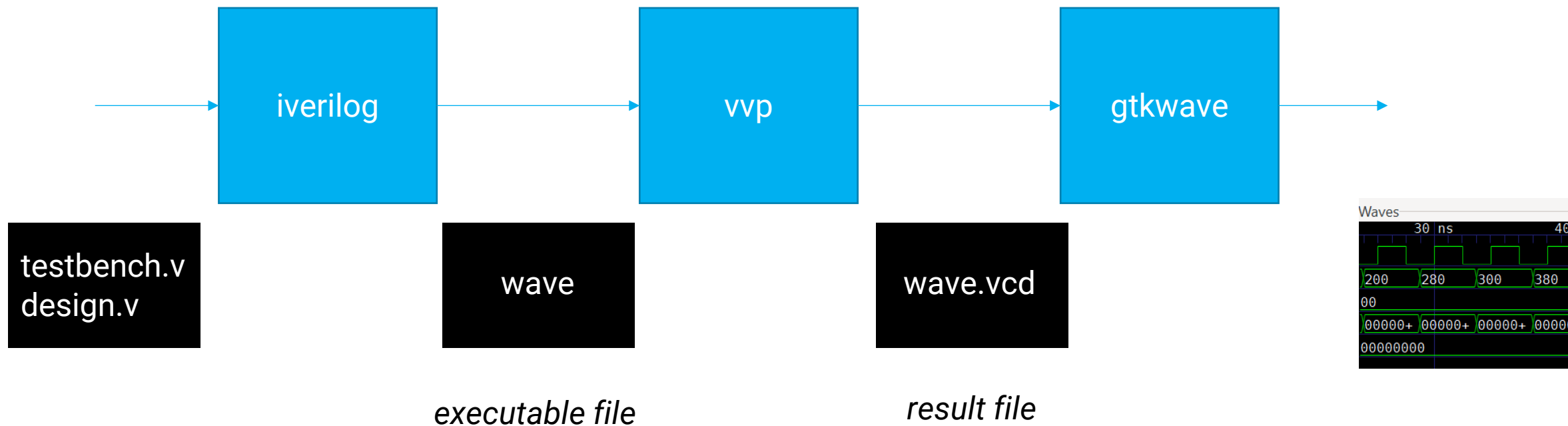

Runnable commend lines:

- 1 `iverilog -o wave testbench.v`
- 2 `vvp -n wave -lxt2`
- 3 `gtkwave wave.vcd -S plot.tcl`

Verilog Simulator Workflow

```
`include "design.v"  
Module testbench;  
  
...  
  
design u1 (...);  
  
endmodule
```

testbench.v

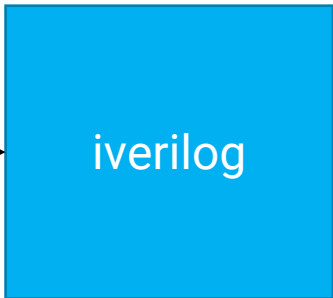

```
plot.tcl  
1 set sigs [list]  
2 lappend sigs "__bug_marker__"  
3 lappend sigs "testbench.CLK\[0\  
4 lappend sigs "testbench.A\[11:0\  
5  
6 set added [ gtkwave::addSignalsFromList $sigs ]
```

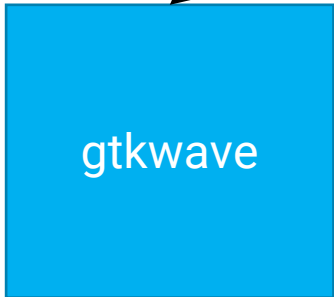

No need to drag outputs every time after running

Runnable command lines:

```
1 iverilog -o wave testbench.v  
2 vvp -n wave -lxt2  
3 gtkwave wave.vcd -S plot.tcl
```

A good tutorial:
[全平台轻量开源verilog仿真工具iverilog+GTKWave使用教程](#)

Other simulators

- Verilator
- PyRTL
- VCS
- Incisive
- Modelsim
- ...

What are their differences?

Part 2

Logic Synthesis

Why synthesis

- Definition: Synthesize logic circuits into gates (gate-level netlist)
- Quick (re)design time
- Separate functionality, technology-dependent parameters, and design constraints
- Fast timing/area/power estimates

Why “synthesis” works? Why can we synthesize logic?

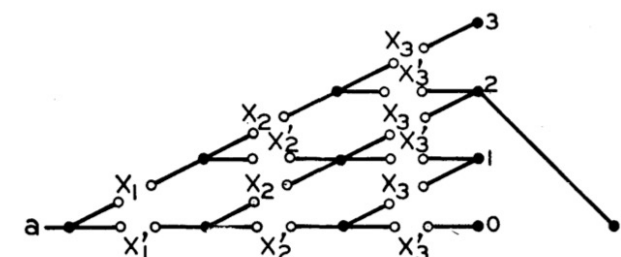

Figure 23. Circuit for realizing $S_2(X_1, X_2, X_3)$

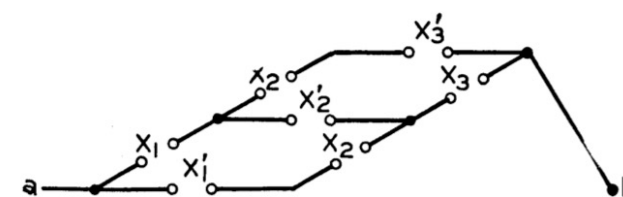
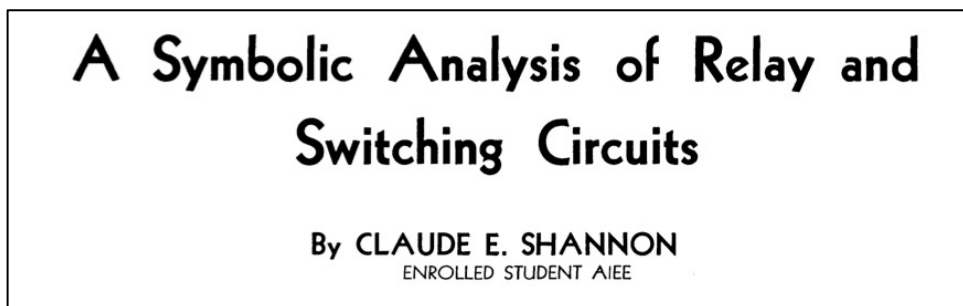
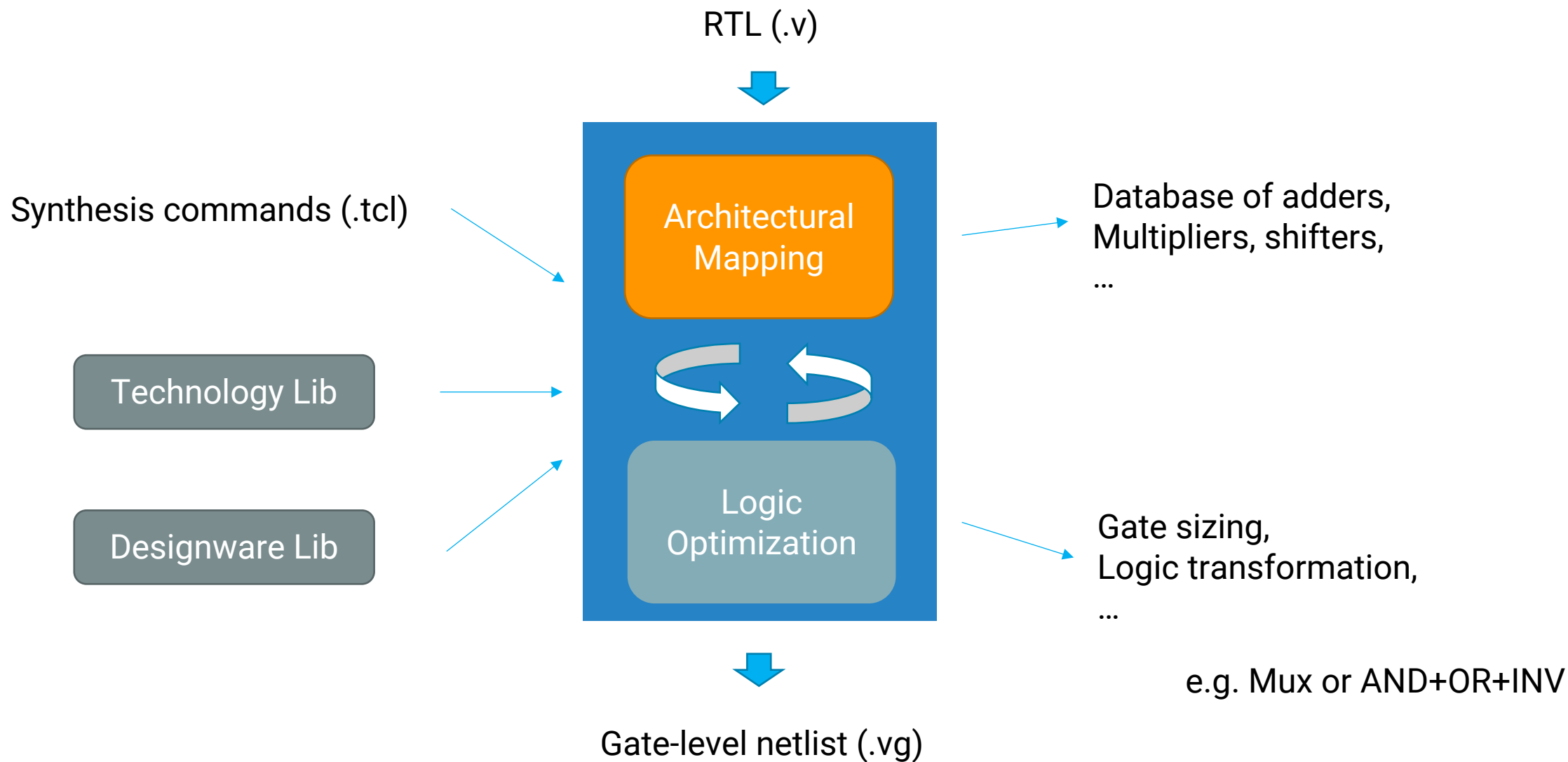

Figure 24. Simplification of figure 23

How to do logic synthesis?



Outputs of logic synthesis?

- Timing/Area/Power reports
- Gate-level netlist (.vg) & timing info. In standard delay format (.sdf) for timing-aware simulation
- Pre-syn (RTL) sim needs: testbench.v, design.v
- Post-syn sim needs: testbench.v, design.vg, design.sdf, stdlib_cells.v

e.g. Assign $C=A+B$

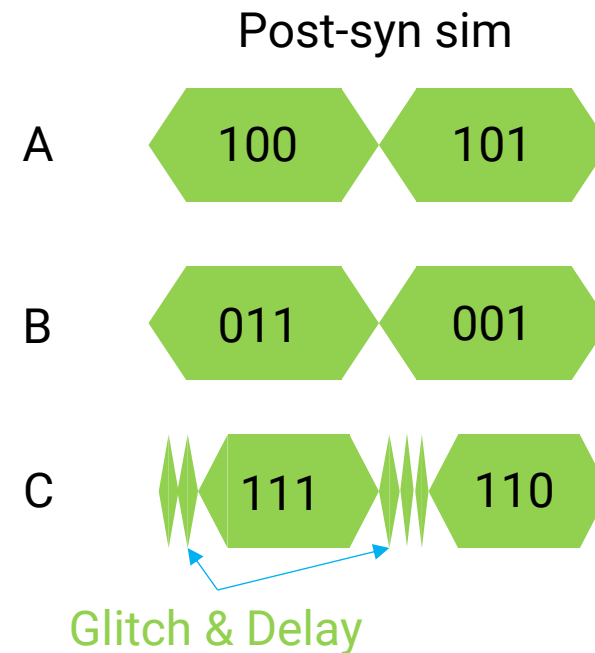

■ ■ Synthesis Tool: Synopsys Design Compiler



- dc_shell-t or dc_shell-xg-t
- Command line approach (no gui)
- Other synthesis tools also work fine:
 - Cadence Genus
 - Open Road: yosys

Script Example (.tcl file)

```
1  remove_design -all
2  source ./SET_CON/T40GP_LibSetup.tcl
3  lappend search_path ./HDL ./SYN
4  analyze -format verilog Adder.v
5  set PROCESS _T40GP
6  set DESIGN_NAME ADD
7  elaborate $DESIGN_NAME
8  link
9  set_operating_conditions -min ff1p16vn40c -max ss0p95v125c
10 set_wire_load_selection_group "predcaps"
11 set TCLK 1.9
12 set TCU 0.1
13 source ./SET_CON/T40GP_VarSetup.tcl
14 set_false_path -from [get_ports ACLR_]
15 uniquify
16 compile -only_design_rule
17 compile_ultra -no_autoungroup
18 compile -inc -only_hold_time
19 set_fix_multiple_port_nets -all -buffer_constants [get_designs *]
20 remove_unconnected_ports -blast_buses [get_cells -hier]
21 report_timing -path full -delay min -max_paths 10 > $LOGPATH$TOPLEVEL$PROCESS.holdtiming
22 report_timing -path full -delay max -max_paths 10 > $LOGPATH$TOPLEVEL$PROCESS.setuptiming
23 report_area -hierarchy > $LOGPATH$TOPLEVEL$PROCESS.area
24 report_power -hier -hier_level 2 > $LOGPATH$TOPLEVEL$PROCESS.power
```

1. Setup technology library

2. Read RTL deign & do architecture mapping

3. Add constraints

4. Compile design

5. Get reports

Logic Synthesis



1. RTL coding
2. Technology lib setup
3. Constraints
4. Major synthesis commands
5. Gate-level simulation

1. **RTL coding**
2. Technology lib setup
3. Constraints
4. Major synthesis commands
5. Gate-level simulation

Write Good HDL

- Different coding styles that are functionally eqvl. may be mapped into HWs having different timing/area

$$E=A+B+C+D$$

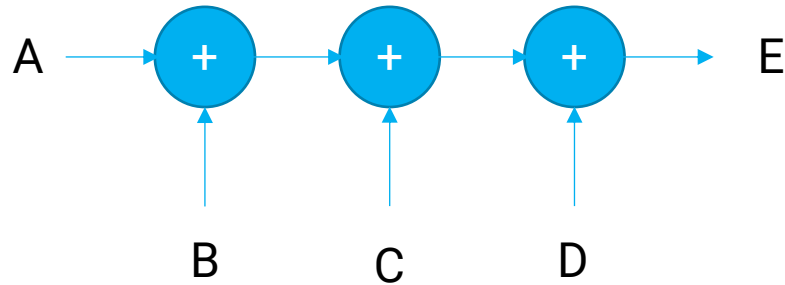

$$E=(A+B)+(C+D)$$

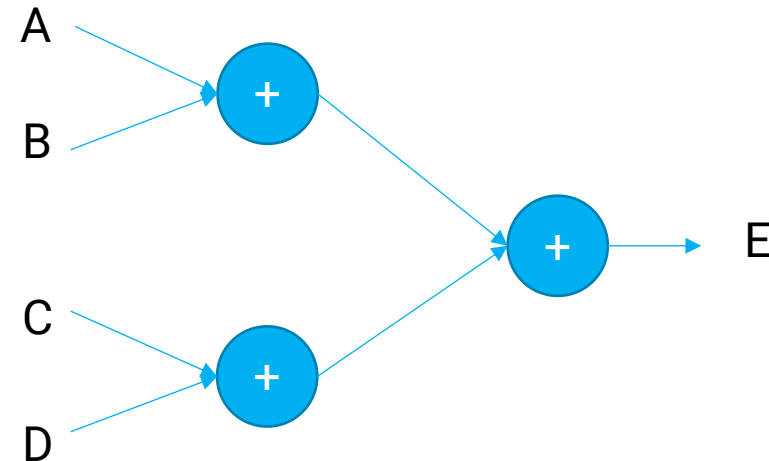

Which is better?

1. RTL coding
- 2. Technology lib setup**
3. Constraints
4. Major synthesis commands
5. Gate-level simulation

Technology Lib about



- Process
- Operating Condition (ss/tt/ff design corner, temperature, VDD voltage)
- Cell Name
- Area
- Functionality
- Pin Capacitance
- Leakage Power
- 7x7 Look-up Tables (LUT) for Dynamic Power & Propagation Delay of all i/o Paths
(idx1: input transition time; idx2: o/p capacitance)
- ...

Setup Tech Lib

```
1 set search_path "$search_path \  
2 /w/apps2/public.2/tech/synopsys/32-28nm/SAED32_EDK/lib/stdcell_rvt/db_nldm"  
3 set target_library "saed32rvt_ff1p16vn40c.db saed32rvt_ss0p95v125c.db"  
4 set link_library "* saed32rvt_ff1p16vn40c.db saed32rvt_ss0p95v125c.db dw_foundation.sldb"  
5 set synthetic_library "dw_foundation.sldb"  
6  
7 # Define work path (note: The work path must exist, so you need to create a folder WORK first)  
8 define_design_lib WORK -path ./WORK  
9 set alib_library_analysis_path "./alib-52/"
```

- DC follows **search_path** to find libraries you specify
- DC uses cells in target library for logic optimization (so we need to do **set_target_library** first)
- **Remember:** Use backslash \ before changing lines to avoid compilation errors.

1. RTL coding
2. Technology lib setup
- 3. Constraints**
4. Major synthesis commands
5. Gate-level simulation

■ ■ Synthesis is Constraint-driven

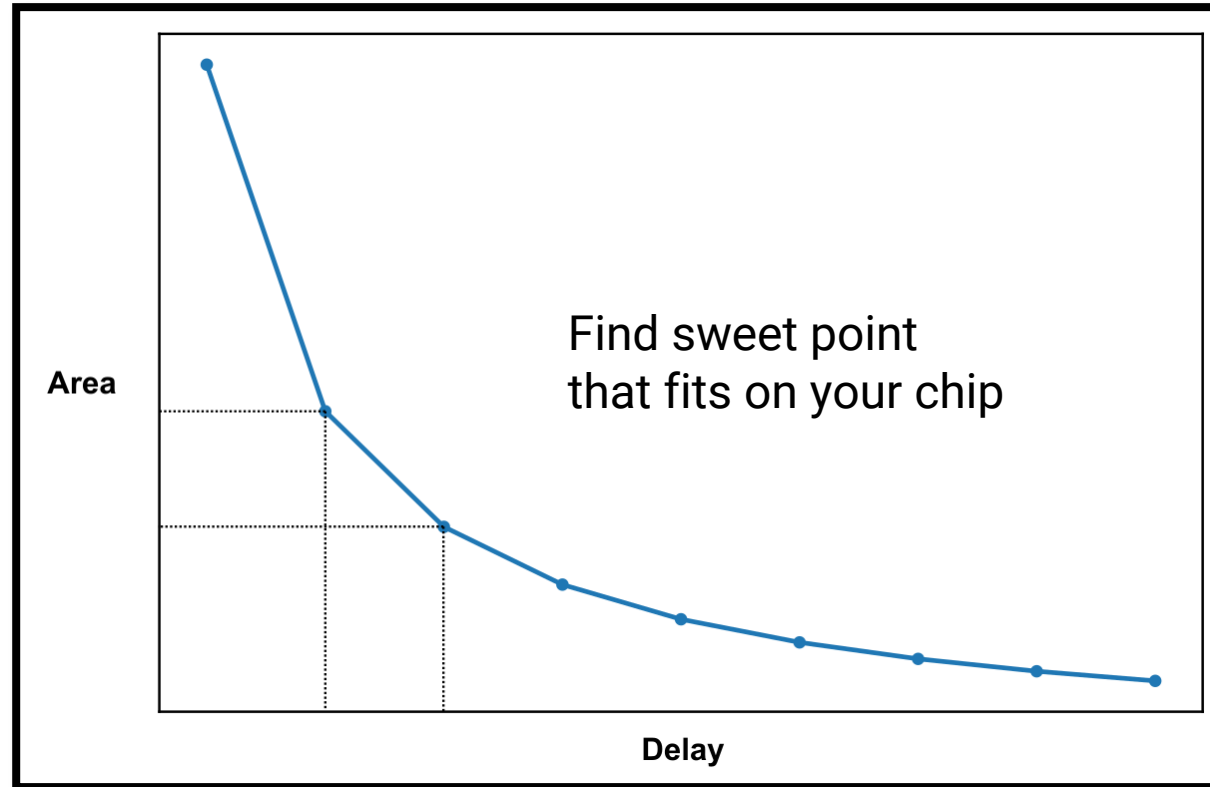

- You set the goals (through **design constraints**)
- DC optimizes the design to meet your goals

Timing Analysis for VLSI

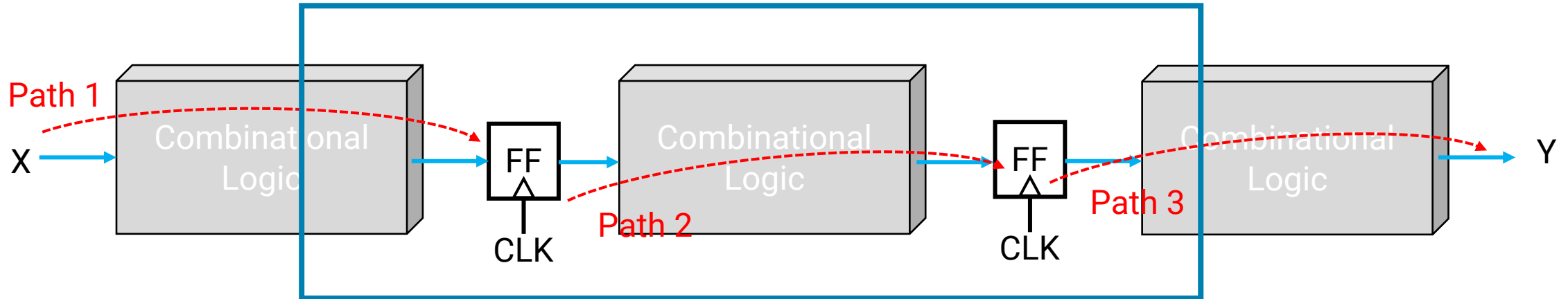

“set_input_delay” : affects input logic

“create_clock” : affects internal logic

“set_output_delay” : affects output logic

Input delay: Arrival of an external path w.r.t. the clock edge

Output delay: timing from an output port of the current design to a register input port of other modules

Describe Constraints

- **Clocks**
 - Period, latency, uncertainty
- **Design rules**
 - Maximum transition
 - Maximum capacitance
 - Maximum fanout
- **Input-related**
 - Driving cells, Input delay
- **Output-related**
 - Load, Output delay
- **Exception paths**
 - False paths, multi-cycle paths
- **Optimization goal**
 - Maximum area/power

Accurate constraints
(not too tight/loose):
Good integ. results

Clock Description

- create_clock: define clock's waveform (e.g. period)

```
create_clock -name "sysclk" -period 2.0 [get_ports "CLK"]
```

- set_fix_hold: respect the hold time requirement of all clocked flip-flops

```
set_fix_hold sysclk
```

- set_dont_touch_network: do not buffer clock network

```
set_dont_touch_network [get_clocks "sysclk"]
```

- Specify uncertainty (skew + jitter) of clock network

```
set_clock_uncertainty 0.1 [get_clocks "sysclk"]
```

- Sets the max_transition attribute to a specified value on specified clocks group, ports or designs

```
set_max_transition 0.1 current_design
```

Constraints: Max transitions, fanout & output loads

- Sets the max_transition, fanout load & output load attribute :

```
set_max_transition 0.1 current_design
```

```
set_max_fanout 1.0 current_design
```

```
set_load 1.0 [all_outputs]
```

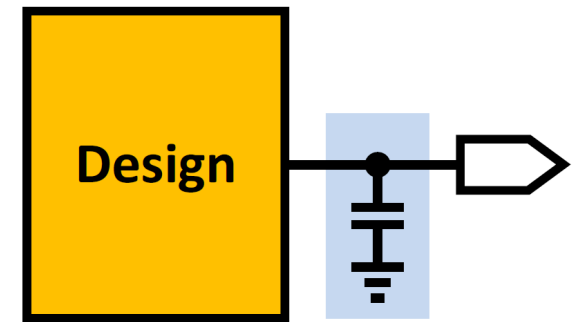
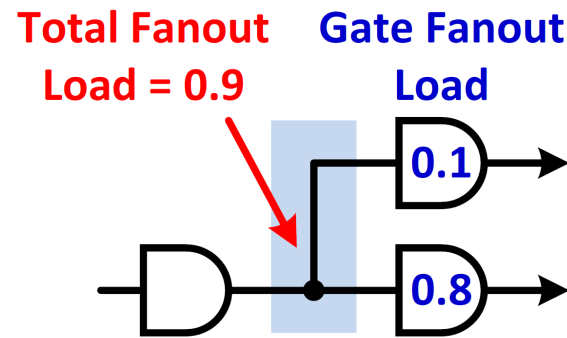
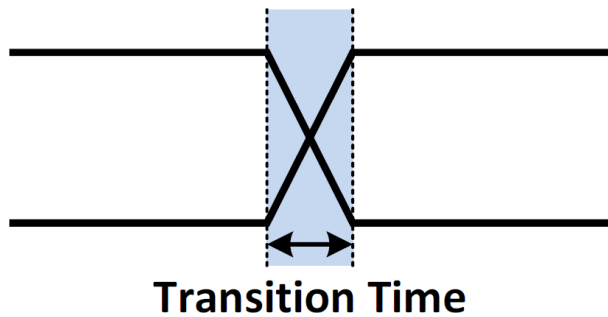

Constraints: Driving Cells

- Sets attributes on input or inout ports of the current design, specifying that a library cell or output pin of a library cell drives specified ports:

```
set_driving_cell [-library lib] [-lib_cell lib_cell_name] [-pin pin_name]
```

```
set ALL_IN_BUT_CLK [remove_from_collection [all_inputs] "CLK"]
```

```
set_driving_cell -no_design_rule -library \  
saed32rvt_ss0p95v125c.db:saed32rvt_ss0p95v125c -lib_cell \  
DFFASRX2_RVT -pin Q $ALL_IN_BUT_CLK
```

Constraints: False Paths

- Removes timing constraints from particular paths, but still needs to satisfy design rule (transition, capacitance, fanout):

```
set_false_path -from [from_list]
```

```
set_false_path -from [get_ports "TEST_OUT1"]
```

Constraints: Maximum Area/Power

- Optimization goals for your design (DC will do it best to satisfy them, w/o violating the three design rules):

```
set_max_area 0.0      ← desired area      um2  
set_max_total_power 0.0 ← desired power    uW
```

```
set_max_area 10000  
set_max_total_power 100
```

Constraints: Operating Condition

- Defines the operating conditions for the current design:

```
set_operating_conditions [-min min_condition] [-max max_condition]
```

hold time check condition

Setup time check condition

```
set_operating_conditions -min ff1p16vn40c -max ss0p95v125c
```

Constraints: Wire-load Models and Modes

- Specify a selection group to use for determining a wire load model to be assigned to designs and cells or to a specified cluster:

```
set_wire_load_selection_group group_name [-max] [-min]
```

```
set_wire_load_selection_group group_name "predcaps"
```

DC will select proper model based on synthesis area (again, lookup this name in .lib file)

1. RTL coding
2. Technology lib setup
3. Constraints
- 4. Major synthesis commands**
5. Gate-level simulation

Commands Preview

- Not all commands introduced are necessarily needed
- Things MUST do

Analyze, elaborate, and link design
Compile design

- Things can do based on your needs

Ungroup; Uniquify
Clock gating creation
Remove unconnected ports

Suggestion: Learn by playing w/ different commands and observing the differences

Analyze Designs:

- Analyzes the HDL files and stores the intermediate format in the specified library.

```
analyze [-format vhdl | verilog | sverilog] file_list
```

```
analyze -format Verilog {adder.v}  
elaborate
```

Or

```
read_verilog adder.v
```

Elabrate & Link Designs



- Builds a design from the intermediate format of a Verilog module, a VHDL entity and architecture, or a VHDL configuration:

```
set design_name adder  
elaborate $design_name
```

or

```
link
```

Ungroup & Uniquify

- Removes a level of hierarchy:

```
ungroup cell_list | -all [-flatten]
```

```
ungroup -flatten -all
```

- Removes multiple-instantiated hierarchy in the current design by creating a unique design for each of the cell instances:

```
uniquify
```

Compile

- Performs logic-level and gate-level synthesis and optimization on the current design:

```
compile [-no_design_rule | -only_design_rule | -only_hold_time] [-  
map_effort medium | high] [-boundary_optimization]
```

```
compile -map_effort high
```

```
compile_ultra
```

Remove Unconnected Ports

- Removes unconnected ports or pins from cells, references, and sub-designs

```
remove_unconnected_ports -blast_buses [get_cells -hier]
```

Report Designs



```
report_timing -path full -delay min -max_paths 10 -nworst 2 > Design.holdtiming
report_timing -path full -delay max -max_paths 10 -nworst 2 > Design.setuptiming
report_area -hierarchy > Design.area
report_power -hier -hier_level 2 > Design.power
report_resources > Design.resources
report_constraint -verbose > Design.constraint
check_design > Design.check_design
check_timing > Design.check_timing
```

Logic Synthesis



1. RTL coding
2. Technology lib setup
3. Constraints
4. Major synthesis commands
- 5. Gate-level simulation**

Slight Modification of Original Testbench.v

- RTL simulation: **design.v** + **testbench.v**
- Gate-level simulation:
 - **design.vg**
 - **design.sdf** (from DC)
 - **testbench.v** (w/ slight modification)

```
`include "design.v"  
Module Testbench;  
  
....  
  
Design u1 (...);  
  
...  
  
endmodule
```

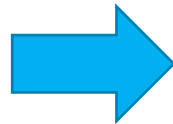

```
`include "design.vg"  
`include "stdlib_cells.v"  
Module Testbench;  
  
....  
  
initial $sdf_annotate("design.sdf", u2);  
  
Design u2 (...);  
  
...  
  
endmodule
```

- If you meet any questions about some commands
- Use

`man set_input_delay`

- Or
- Search on Baidu/Bing/Google/...



Summary



- Synthesis tool makes VLSI design a lot easier
 - Easy to use: **.v** files + **.tcl** files
 - Easy to switch designs to any technology by changing associated libraries
 - Easy to have accurate area/timing/power estimate
 - Easy to match the best archit. with design constraints
- **But... not a substitute for thinking**
 - Mind your coding styles
 - Handmade optimization (e.g. using shift-and-add for variables' multiplication) still needed